

	±				kyu213-0075	
	100kV							2
								
				1:2,500				

5,100,000

5,200,000

-246,100,000

-246,100,000

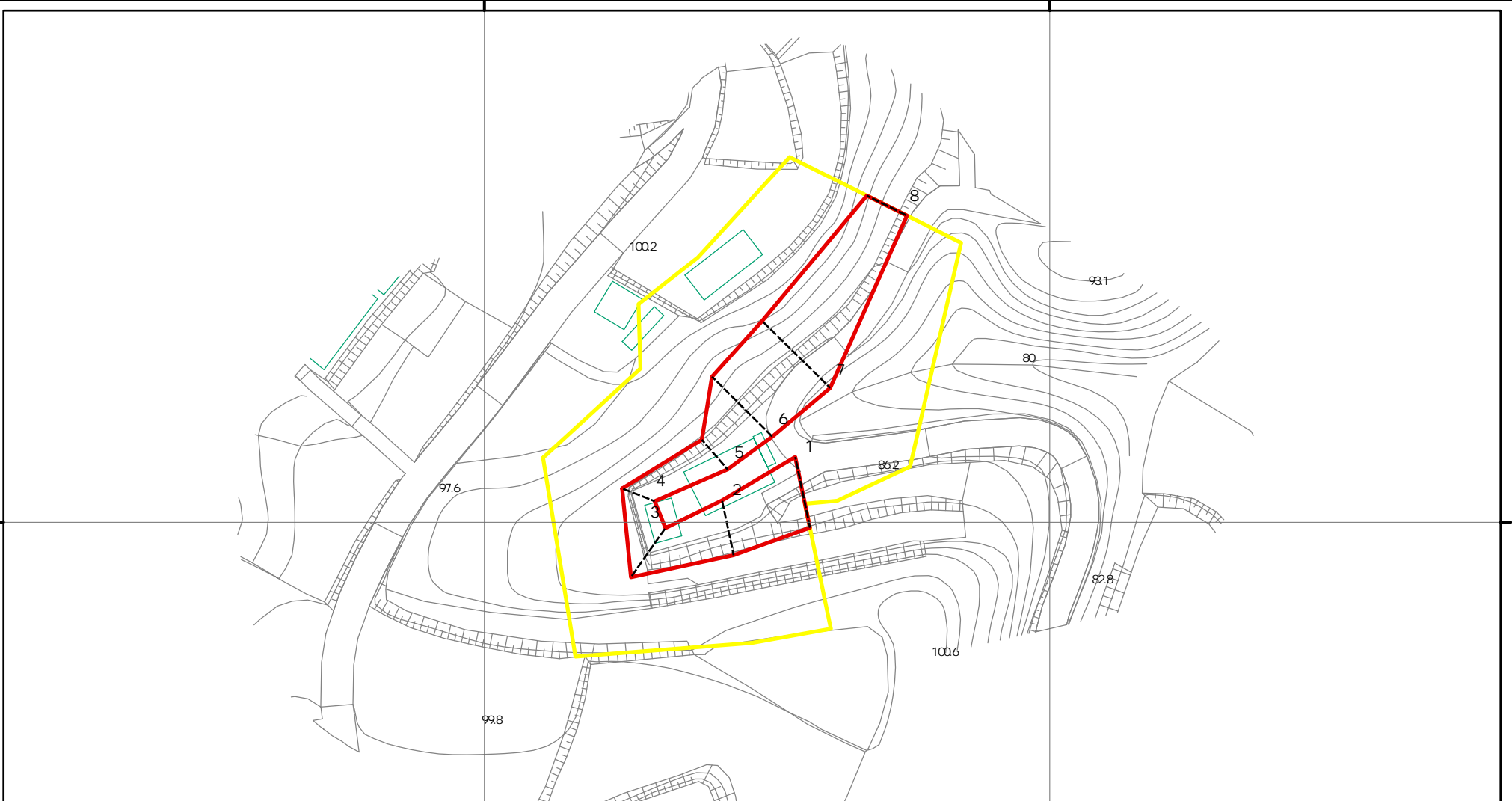

5,100,000

5,200,000

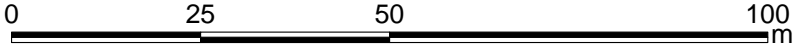

							kyu213-0075
	100KV		\pm				2
			1:1,000				

5,100,000

5,200,000

-246,100,000

-246,100,000

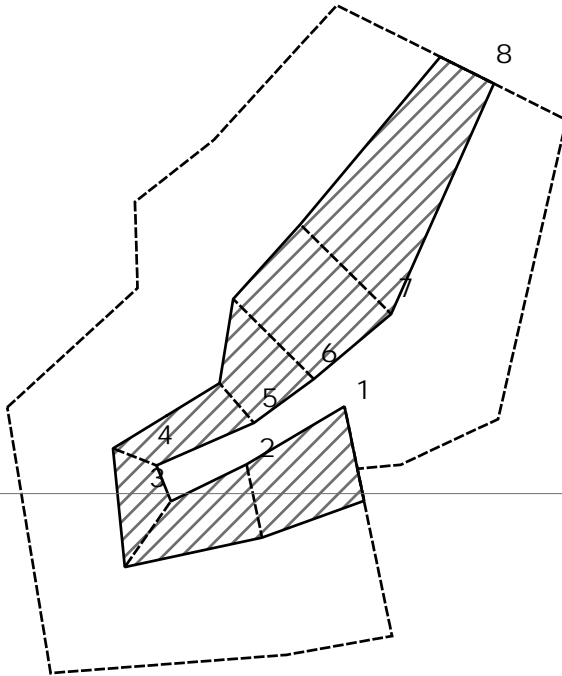

5,100,000

5,200,000

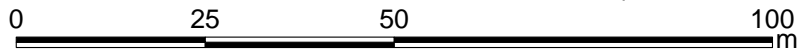

			±				kyu213-0075
	100kV						
			1:1,000				

5,100,000

5,200,000

-246,100,000

-246,100,000

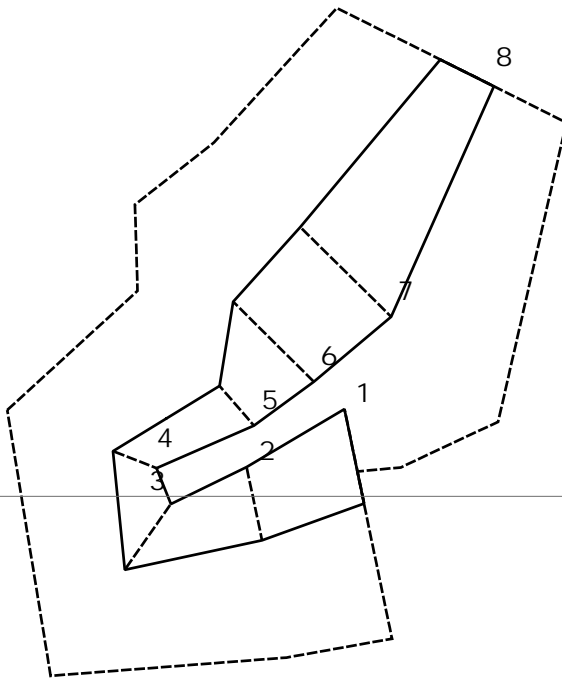

5,100,000

5,200,000

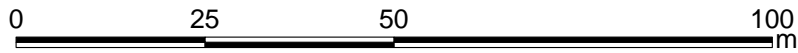

±

1:1,000

kyu213-0075

2

		m 100kN/m ²				m				m 100kN/m ²				m			
		kN/m ²	m	kN/m ²	m	kN/m ²	m	kN/m ²	m	kN/m ²	m	kN/m ²	m	kN/m ²	m	kN/m ²	m
1	2	-	-	8018	1.00	-	-	7.32	1.66								
2	3	-	-	8018	1.00	-	-	7.32	1.66								
3	4	-	-	77.56	1.00	-	-	7.79	1.77								
4	5	-	-	66.74	1.00	-	-	7.79	1.77								
5	6	-	-	8018	1.00	-	-	8.09	1.84								
6	7	-	-	10000	1.00	-	-	9.21	2.09								
7	8	-	-	10000	1.00	-	-	9.21	2.09								
												kyu213-0075					
												2					

