

	+
	
	
	

100kV

1:2,500

kyu213-0055

1

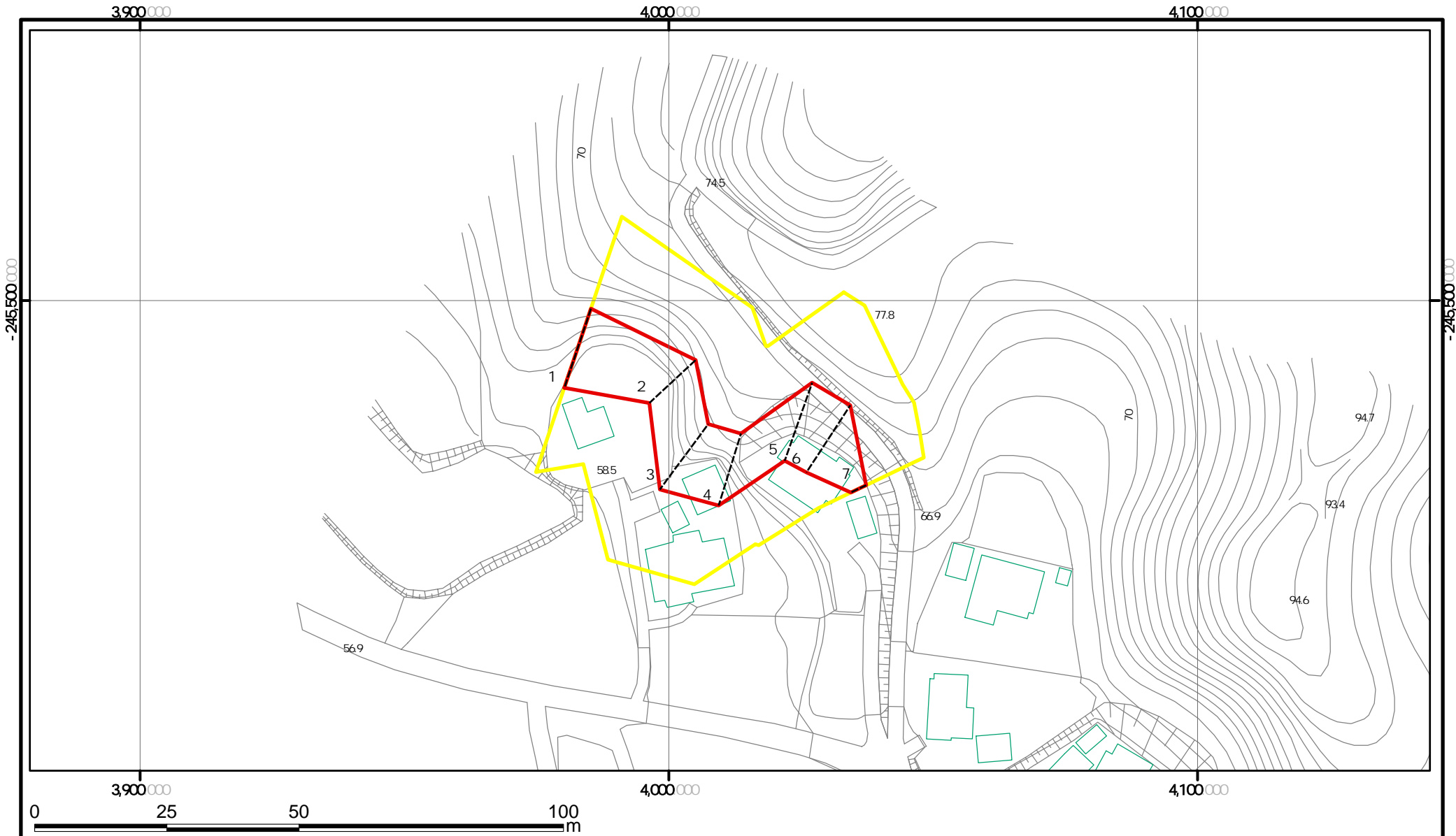

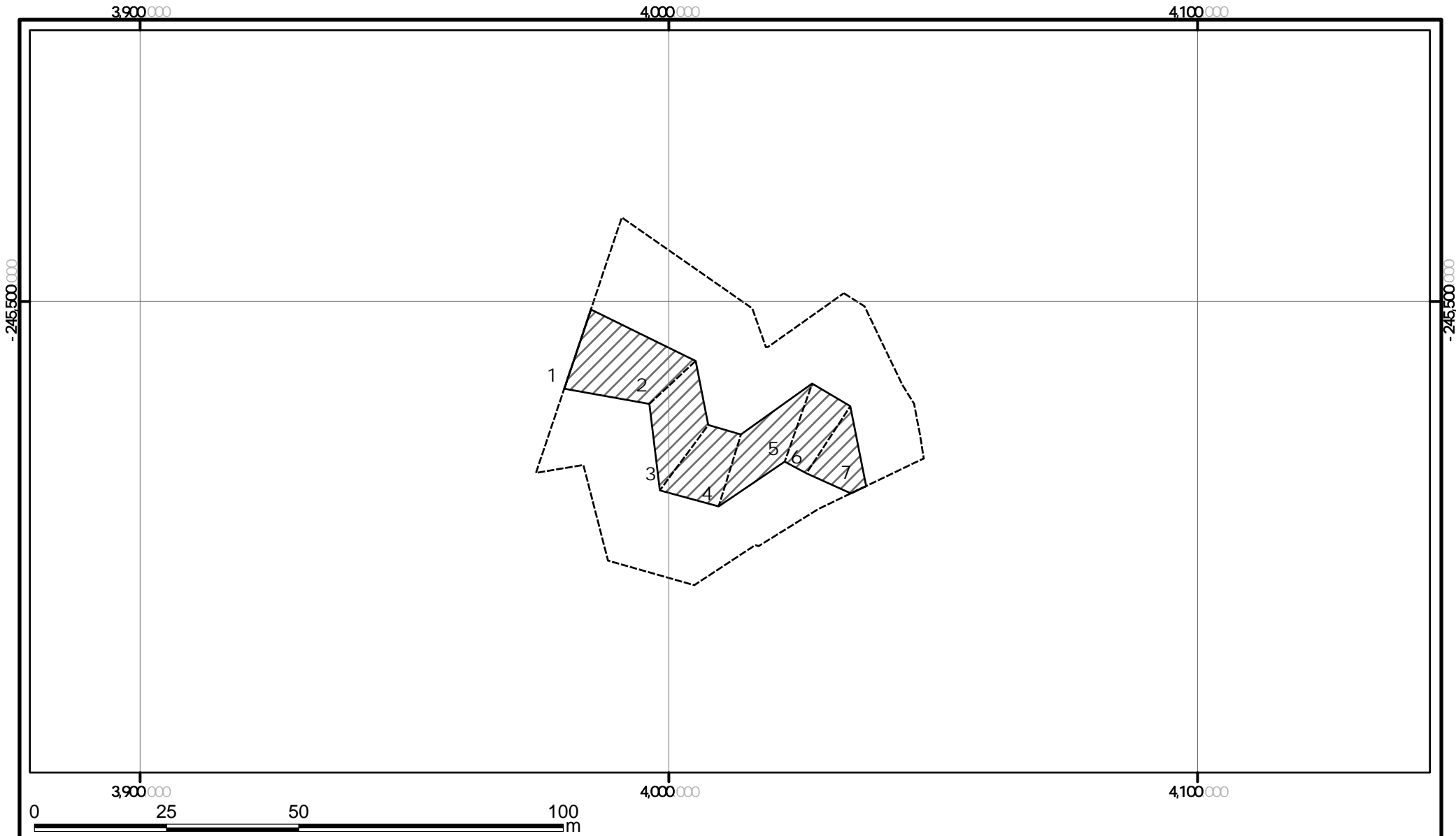

	±	kyu213-0055
	1:1,000	

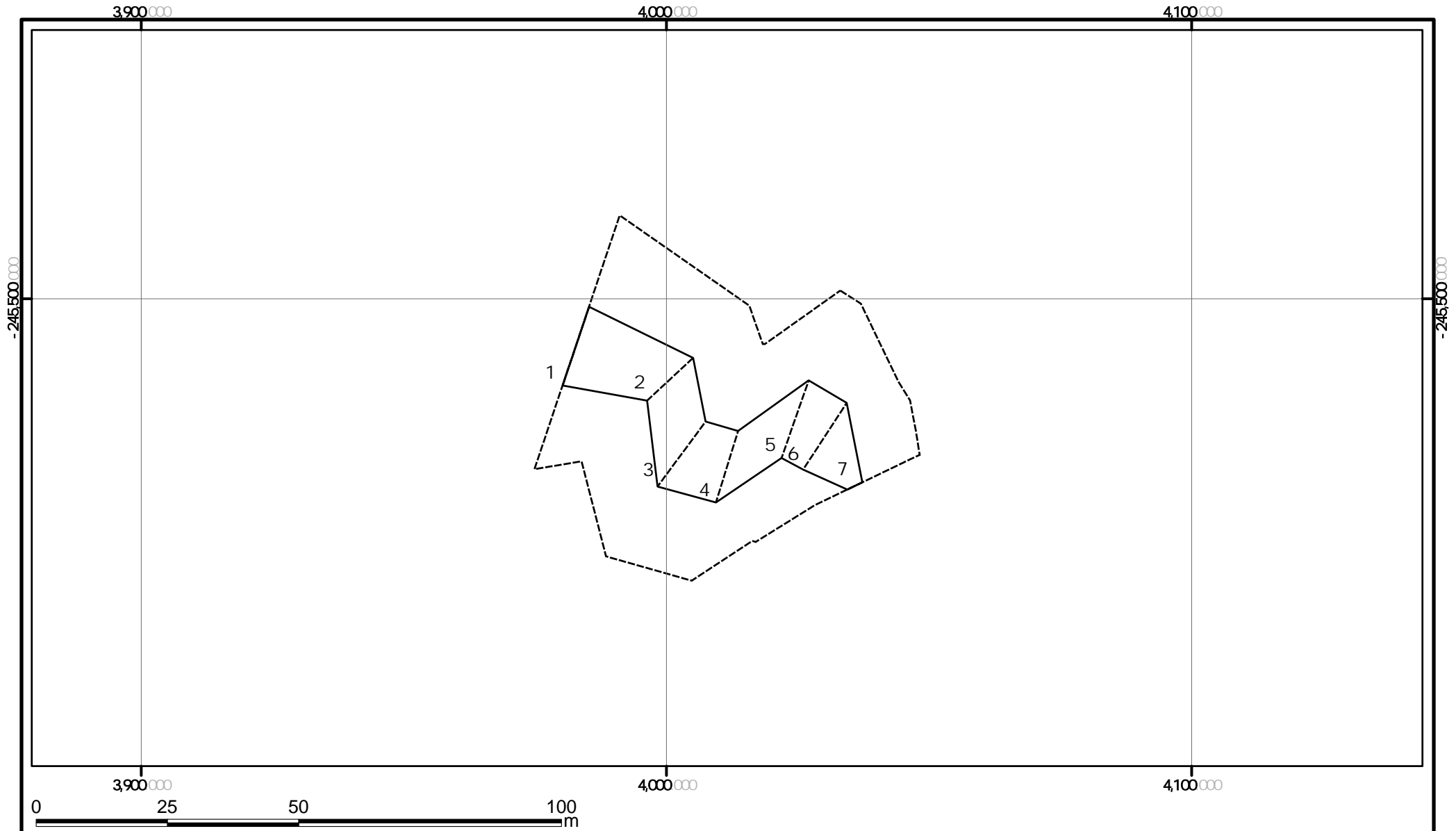

			±				kyu213-0055
	100kV						1
			1:1,000				



			±				kyu213-0055
							1
			1:1,000				

