









	±				kyu213-0076
	100kV						
			1:2,500				
							

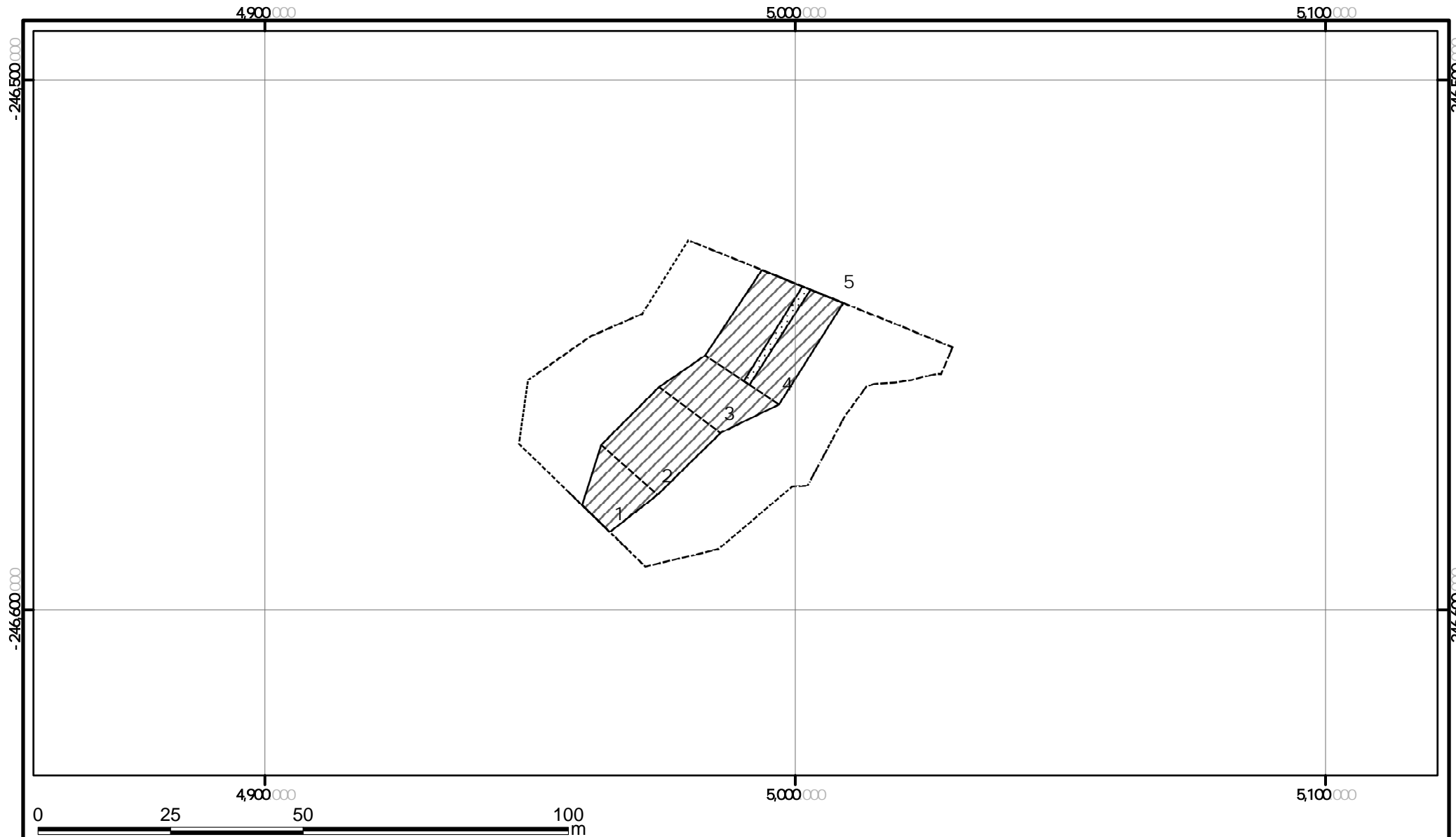

			±				kyu213-0076
	100kV						3
			1:1,000				

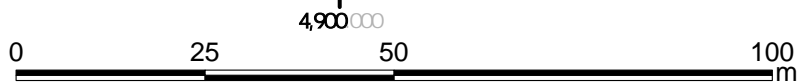
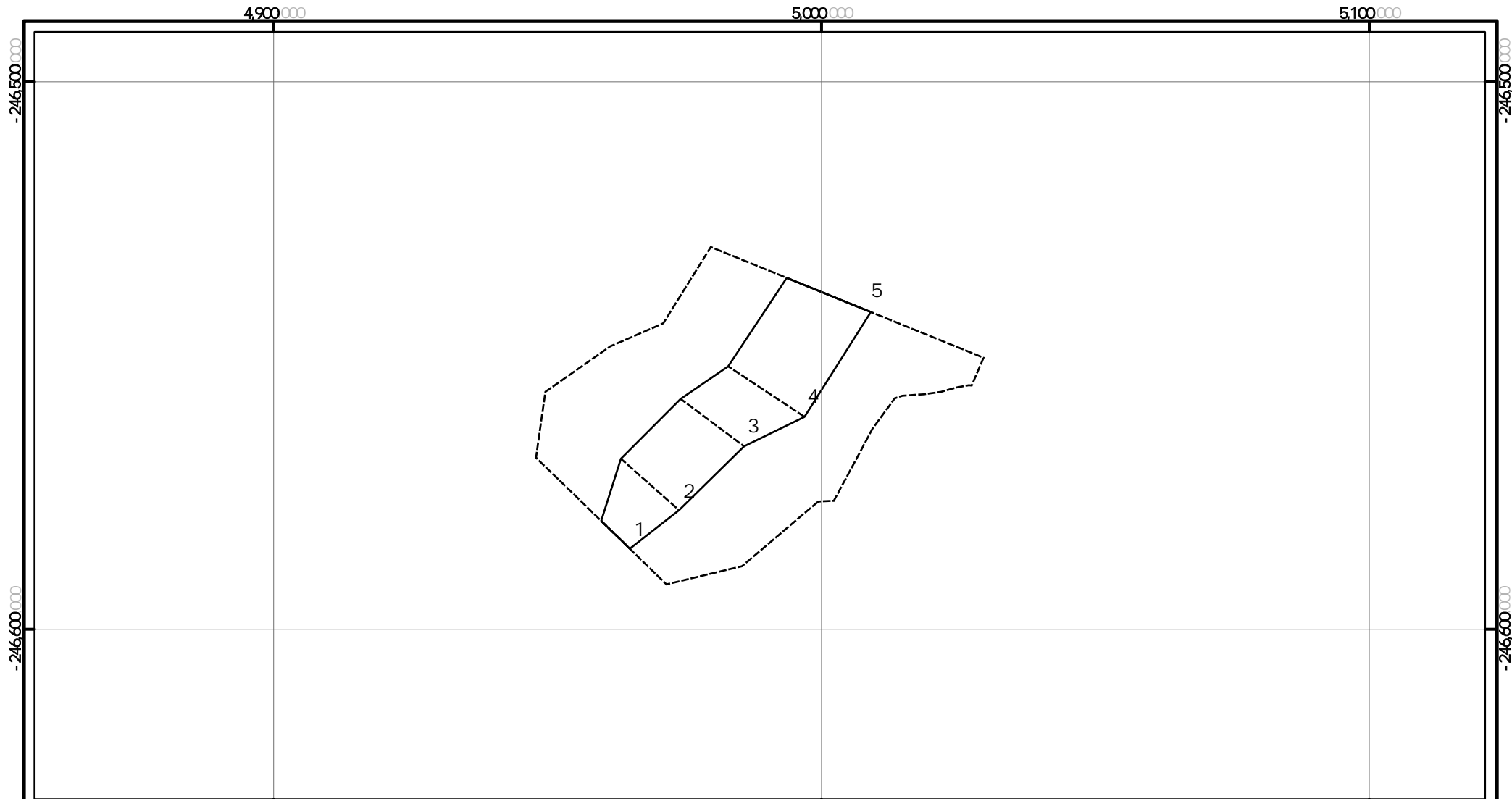

			±				kyu213-0076
							
			1:1,000				

