

	+				kyu213-0013
	100kV						
			1:2,500				
							



±
1:1,000

100KV

kyu213-0013

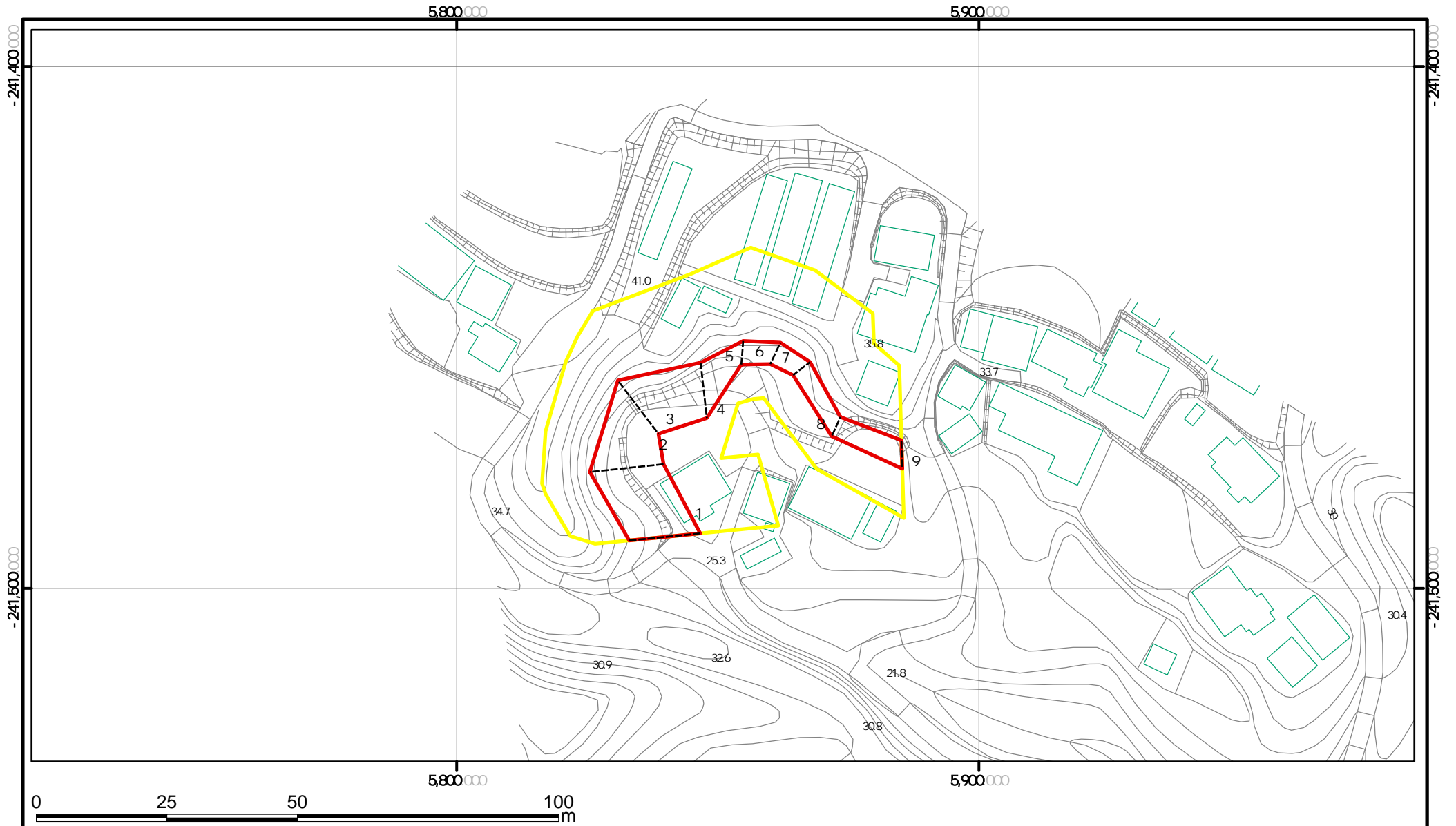
5

5,800,000

5,900,000

-241,400,000

-241,400,000

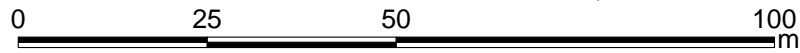
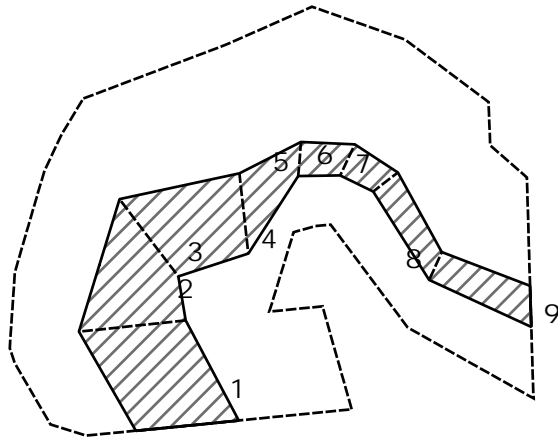

-241,500,000

-241,500,000



5,800,000

5,900,000

			±				kyu213-0013
	100kV						5
			1:1,000				

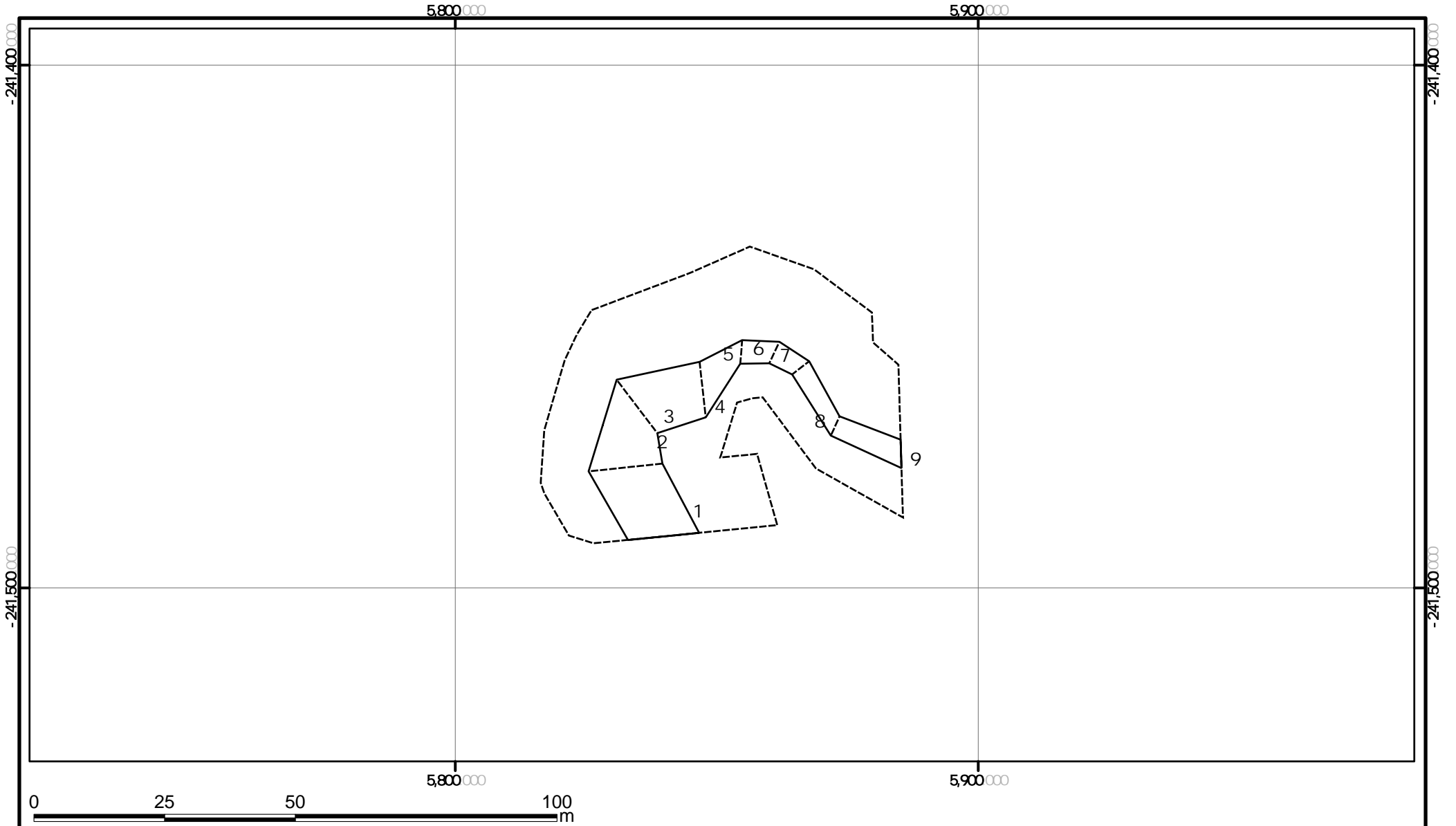

±

1:1,000

kyu213-0013

5

